

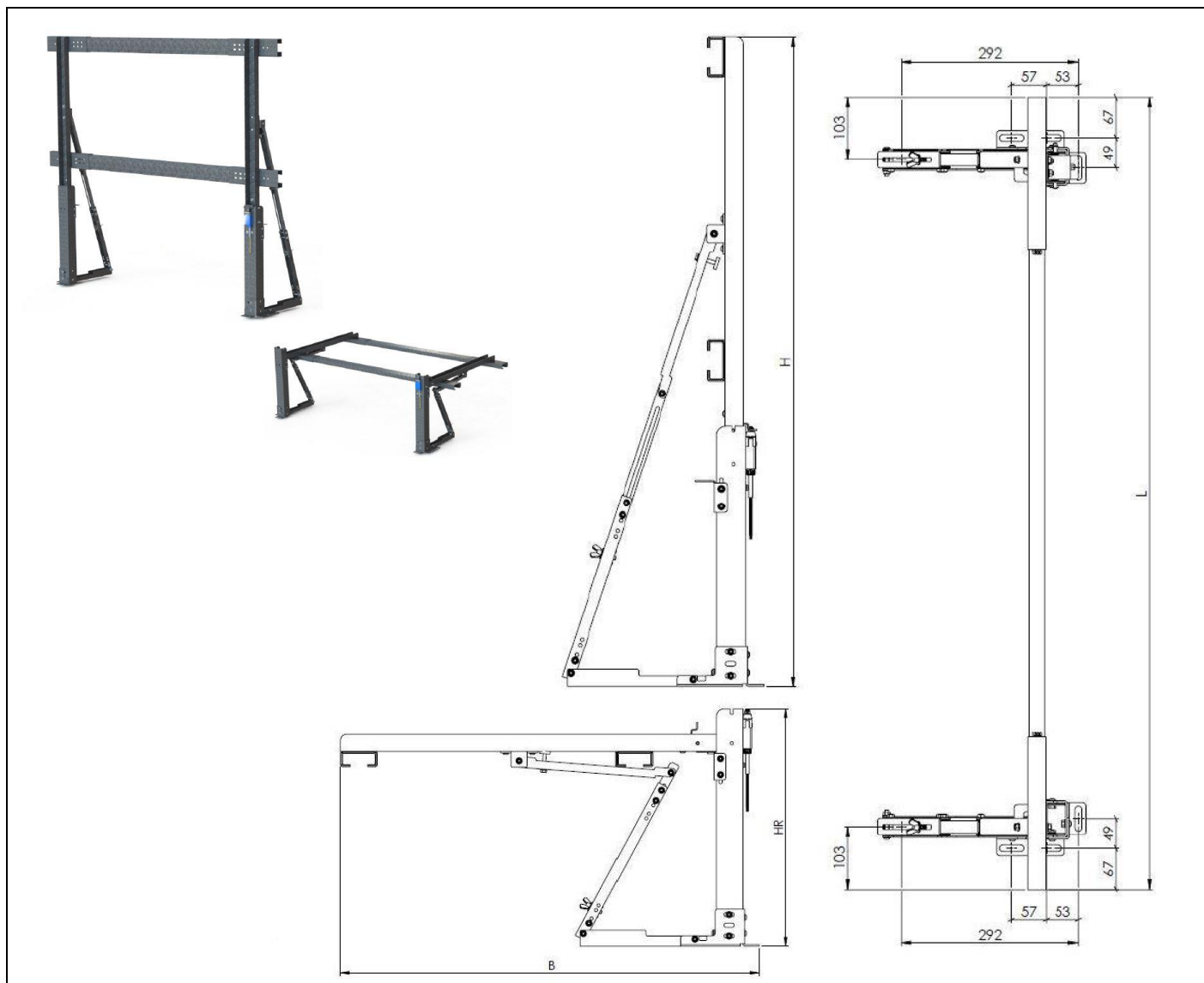

BARANDILLA ABATIBLE OKATT BF200 H1100 L950
FOLDABLE ROOF HANDRAIL OKATT BF200 H1100 L950
BALUSTRADE TOIT CABINE PLIABLE OKATT BF200 H1100 L950

CODIGO

526783



DATOS TECNICOS

TECHNICAL DATA

DONNÉES TECHNIQUES

L (mm)	CODE	H (mm)	HR (mm)	B (mm)	Contactos / Safety Switch
850	527445	1100	445	788	2 x NC : EN 81-20
950	526783				
1040	526232				
1100	527718				
1320	526480				

- EN 81-21, EN 81-20