



GATILLO DE ARRASTRE

PULLING TRIGGER

GÂCHETTE DE TRACTION

CODIGO

527926

527925



527926

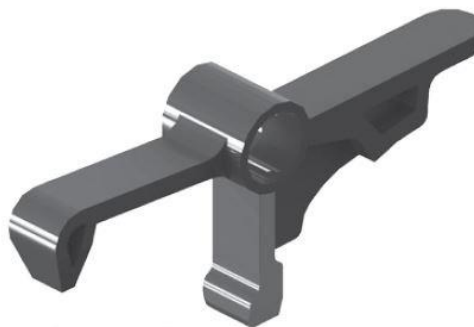

DATOS TECNICOS

TECHNICAL DATA

DONNÉES TECHNIQUES

- **FABRICANTE/MANUFACTURER/FABRICANT:** FERMATOR
- **TIPO PUERTA/DOOR TYPE/PORTE TYPE:** 40/10 PM
- **FAMILIA PRODUCTO/FAMILY PRODUCT/FAMILLE PRODUIT:** DSK

CODE	AÑO/YEAR/ANNE	FERMATOR CODE
527925	>2013	DSK-10GA.C0000
527926	<2013	DSK-10G1.C0000