



JUEGO DE JUNTAS PISTON 9000 T85 C2

SEALS PISTON SET 9000 T85 C2

JOINTS PISTON SET 9000 T85 C2

CODIGO

528127

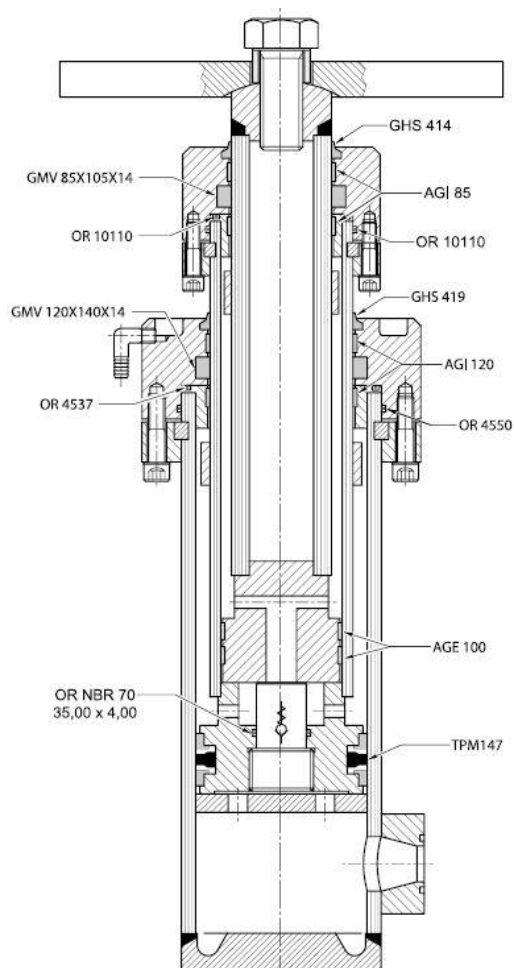

DATOS TECNICOS

TECHNICAL DATA

DONNÉES TECHNIQUES

- FABRICANTE/MANUFACTURER/FABRICANT: GMV
- PRODUCTO/PRODUCT/PRODUIT: R83604010

CODE	ETAPAS/ STAGES	PISTON
528124	2	T50 C2
528125		T63 C2
528126		T70 C2
528127		T85 C2
528128		T100 C2

CODE	ETAPAS/ STAGES	PISTON
528129	3	T50 C3
528130		T63 C3
528131		T70 C3
528132		T85 C3
528133		T100 C3