



MG9A – DERIVACION SERIE PUERTAS AUTOMATICAS 8m

MG9A – AUTOMATIC DOOR SERIES STUB CABLE 8m

MG9A – CÂBLE DERIVATION SERIE PORTES AUTOMATIQUES 8m

CODIGO

528170

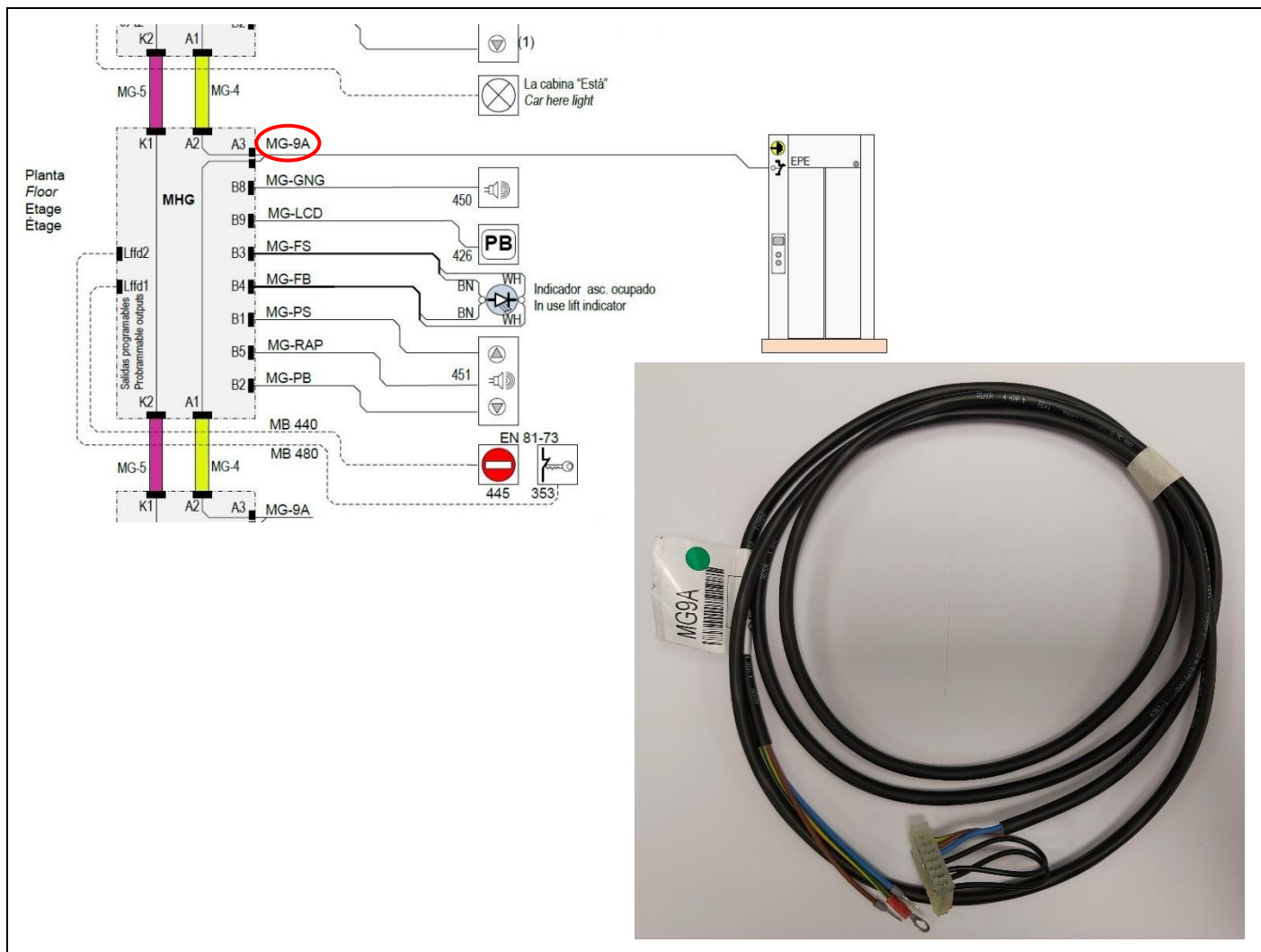

DATOS TECNICOS

TECHNICAL DATA

DONNÉES TECHNIQUES

- **FABRICANTE/MANUFACTURER/FABRICANT:** Carlos Silva
- **PRODUCTO/PRODUCT/PRODUIT:** MG9A

CODE	L (m)	CARLOS SILVA CODE
528167	2.5	CC699A025
528168	4	CC699A040
528169	6	CC699A060
528170	8	CC699A080
528171	10	CC699A0A0