



MGGNG – MANGUERA GONG BITONAL (B8) 3m

MGGNG – TWO TONE GONG HOSE (B8) 3m

MGGNG – TUYAU GONG BITONAL (B8) 3m

CODIGO

528177

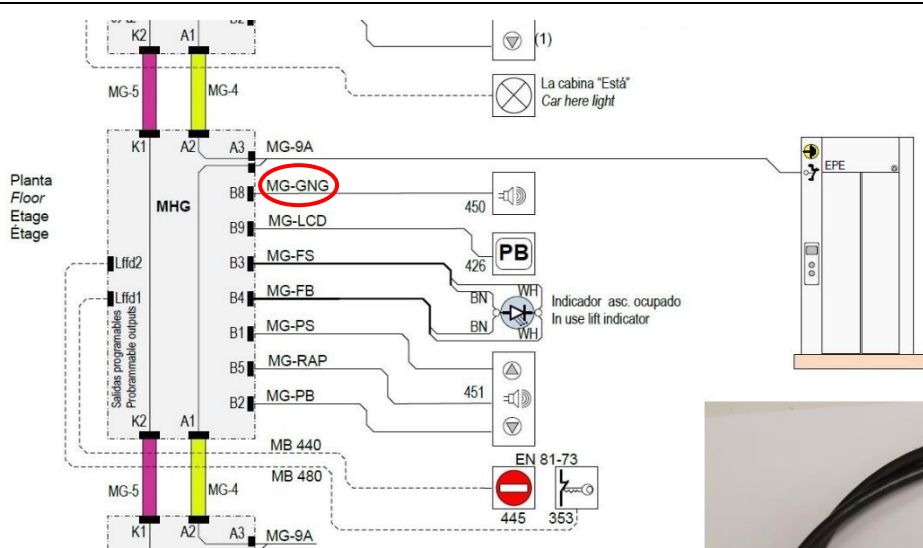

DATOS TECNICOS

TECHNICAL DATA

DONNÉES TECHNIQUES

- **FABRICANTE/MANUFACTURER/FABRICANT:** Carlos Silva
- **PRODUCTO/PRODUCT/PRODUIT:** MG-GNG

CODE	L (m)	CARLOS SILVA CODE
528176	1.5	CC6750815
528177	3	CC6750830
528178	4.5	CC6750845
528179	5	CC6750850
528180	6	CC6750860
528181	8	CC6750880
528182	10	CC67508A0