



MGFS – MANGUERA FLECHA SUBIR 4.5M

MGFS – ARROW UP HOSE 4.5M

MGFS – FLECHE EN HAUT 4.5M

CODIGO

528191

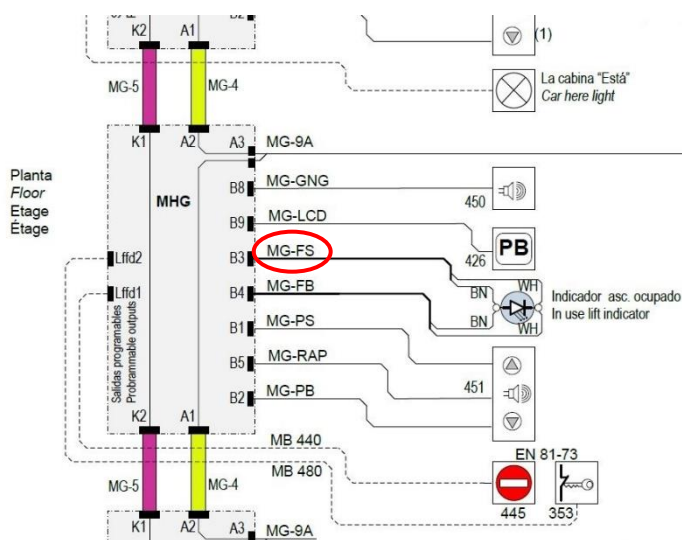

DATOS TECNICOS

TECHNICAL DATA

DONNÉES TECHNIQUES

- **FABRICANTE/MANUFACTURER/FABRICANT:** Carlos Silva
- **PRODUCTO/PRODUCT/PRODUIT:** MG-FS

CODE	L (m)	CARLOS SILVA CODE
528189	1.5	CC6750315
528190	3	CC6750330
528191	4.5	CC6750345
528192	6	CC6750360
528193	10	CC67503A0