



MGPS – MANGUERA PULSADOR SUBIDA 1.5M

MGPS – UP BUTTON HOSE 1.5M

MGPS – BOUTON DE MONTEE 1.5M

CODIGO

528204

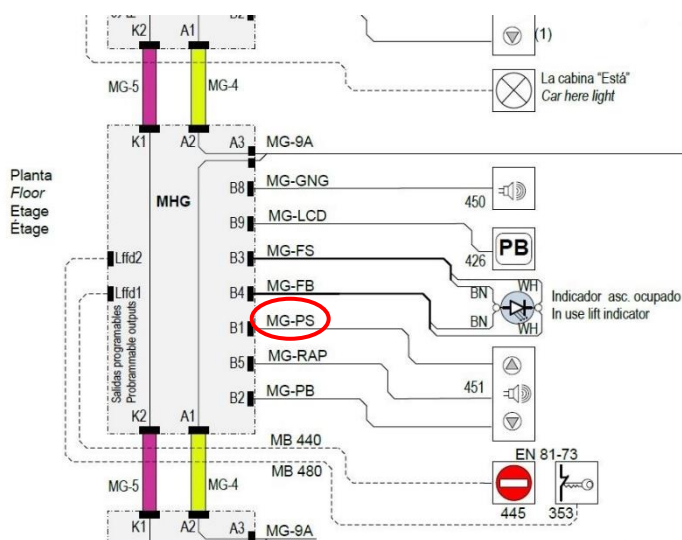

DATOS TECNICOS

TECHNICAL DATA

DONNÉES TECHNIQUES

- **FABRICANTE/MANUFACTURER/FABRICANT:** Carlos Silva
- **PRODUCTO/PRODUCT/PRODUIT:** MG-PS

CODE	L (m)	CARLOS SILVA CODE
528204	1.5	CC6770115
528205	3	CC6770130
528206	4.5	CC6770145
528207	6	CC6770160
528208	10	CC67701A0